



SERVE YOUR GUESTS IN STYLE

Indoor/Outdoor Bar Cart

Entertain in simple style with this sturdy and versatile bar cart. Assembly is fast and easy with 2x4 lumber and Simpson Strong-Tie® Rigid Tie® RTC2Z connectors. Swiveling casters roll smoothly and lock securely, and trim rails ensure that bottles and glassware are safe in transit. Use cedar or redwood for that natural look, or use non-treated lumber and personalize it with your favorite paint color.



Check out our installation and building-tip videos at www.diydoneright.com.

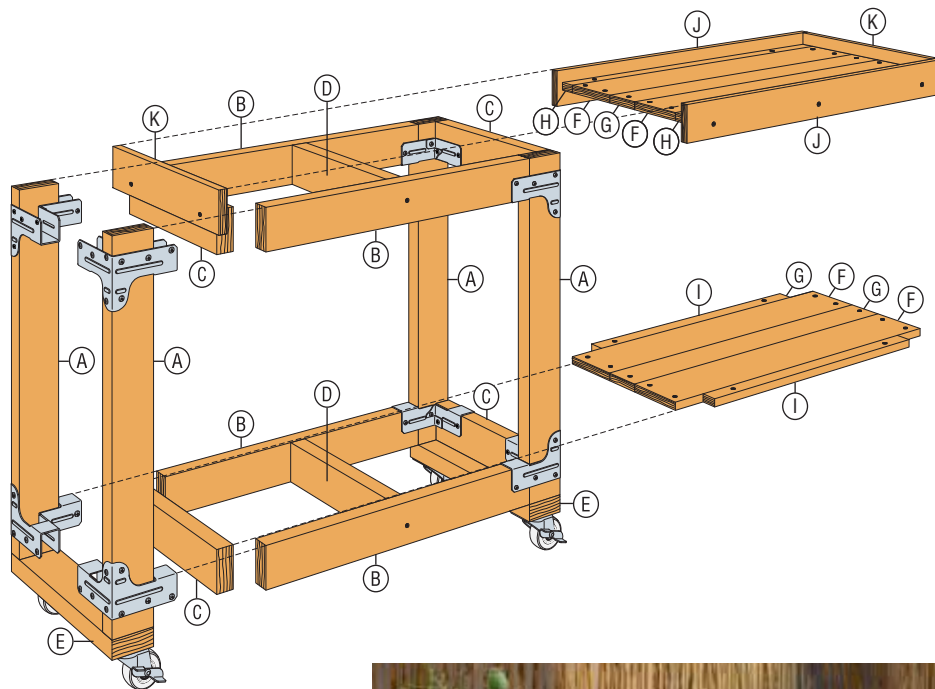

TOOLS YOU NEED

- Saw
- Drill/Screw gun
- #2 Philips head bit
- Tape measure
- Framing square
- Pencil
- Clamps

INSTALLATION INSTRUCTIONS

- CUT LUMBER TO SIZE WITH STRAIGHT CUTS.** Simpson Strong-Tie® connectors make it easy to create strong right-angle connections using 2x4s.
- ATTACH CONNECTORS TO LEGS.** Attach two connectors to each leg (A) with wafer-head screws, placing one 1 3/8" down from the top of leg and one 1 3/8" up from the bottom of the leg. The two connectors on each leg will be symmetrical. Be sure to position them as shown in the illustration.
- ATTACH HORIZONTAL RAILS.** Attach long horizontal rails (B) and short horizontal rails (C) to leg assemblies with wafer-head screws.
- ATTACH CENTER SUPPORTS.** Attach center supports (D) to long rails (B) with #10x2 1/2" Deck-Drive™ DSV Wood screws (at both top and bottom of cart).
- ATTACH CASTER SUPPORTS.** Attach caster supports (E) to the short ends of the cart using three #10x2 1/2" DSV screws on each side. Attach casters to (E) with #8x1 5/8" DSV screws.
- ATTACH PLANKS.** Attach two wide planks (F), one center plank (G) and two longer narrow planks (H) to top of cart with #8x1 5/8" DSV screws. Then attach two wide planks (F), center plank (G) and two shorter narrow planks (I) to bottom shelf with #8x1 5/8" DSV screws.
- ATTACH TRIM RAILS.** Attach two long trim rails (J) and two short trim rails (K) just above the connectors with #8x1 5/8" DSV screws.



MATERIALS AND CUTTING DIAGRAM



Indoor/Outdoor Bar Cart

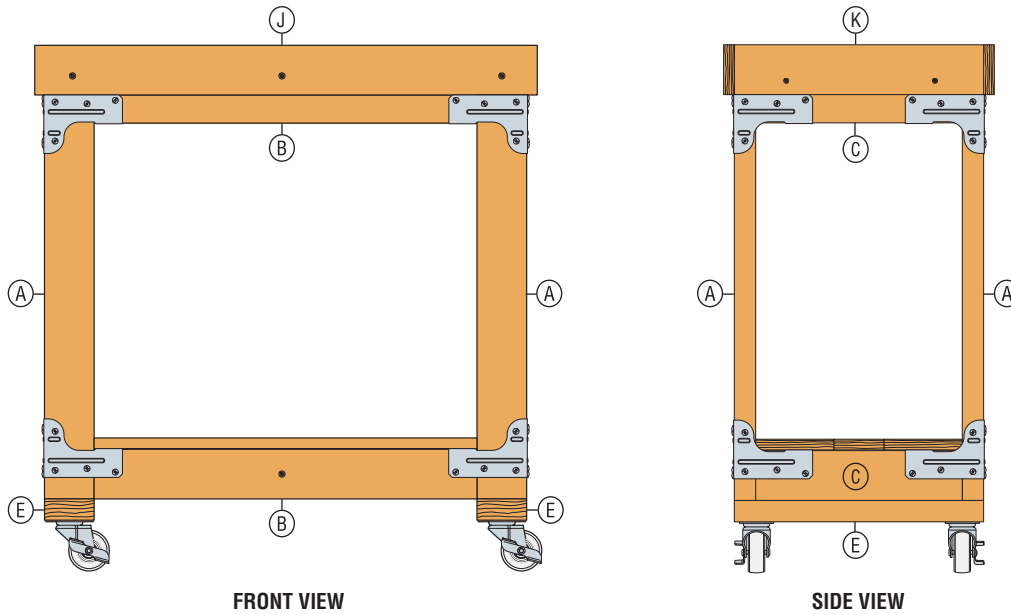

FOR THIS PROJECT YOU WILL NEED:

LUMBER*

- (4) pieces 2x4 x 8' lumber
- (2) pieces 1x2 x 8' lumber
- (2) pieces 1x4 x 8' lumber
- (2) pieces 1x6 x 6' lumber

* Use redwood, cedar or non-treated wood.

SIMPSON STRONG-TIE® CONNECTORS AND FASTENERS

- (8) Rigid Tie® RTC2Z connectors
- (1) box Simpson Strong-Tie® #8x1 1/4" Wafer-Head screws
- (1) box Simpson Strong-Tie® #8x1 5/8" Deck-Drive™ DSV screws
- (10) #10x2 1/2" Deck-Drive™ DSV screws

CUT FROM 2x4 x 8' LUMBER

- (4) 30" Legs
- (4) 14 1/4" Short rails
- (2) 27" Long rails
- (2) 17 1/4" Caster supports
- (2) 27" Long rails
- (2) 14 1/4" Center supports

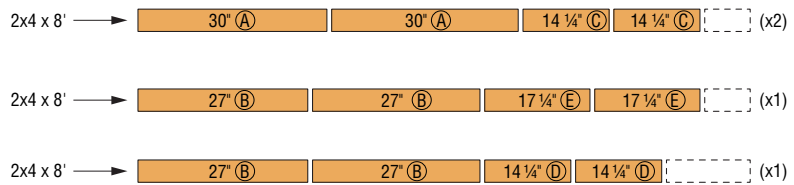

CUT FROM 1x2 x 8' LUMBER

- (2) 27" Bottom trim planks
- (2) 34" Top trim planks

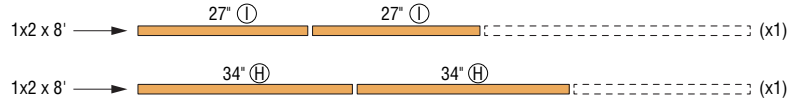

CUT FROM 1x4 x 8' LUMBER

- (2) 34" Center plank
- (1) 17 3/8" Short trim rail
- (2) 35 7/16" Long trim rail
- (1) 17 3/8" Short trim rail

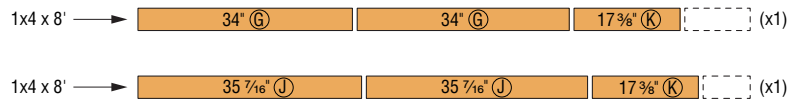

CUT FROM 1x6 x 6' LUMBER

- (4) 34" Wide planks



The construction plan for this project is designed to be completed by people with basic carpentry skills in standard situations. If your situation is unique, talk with someone with detailed carpentry or construction experience before starting your project. Particular attention was paid to the steps and details in this plan, but they cannot be guaranteed to be error free. Simpson Strong-Tie shall not be responsible for any possible loss, damage or injury resulting directly or indirectly from the information contained here.

© 2015 Simpson Strong-Tie Company Inc. • P.O. Box 10789, Pleasanton, CA 94588

DIY-CSBARCART15 7/15 exp. 12/16

(800) 999-5099
www.strongtie.com