



## STURDY FENCES THAT STAND UP TO THE ELEMENTS

# Wood Fencing

Simpson Strong-Tie makes it affordable for you to build a fence that will withstand the test of time, and best of all, complement the character and design of your home. Your style, your way. Building a fence with Simpson Strong-Tie® connectors can save you the cost of hiring a contractor and save on long-term costs by adding strength that minimizes repairs.



Check out our installation and building tip videos at [www.diydoneright.com](http://www.diydoneright.com).

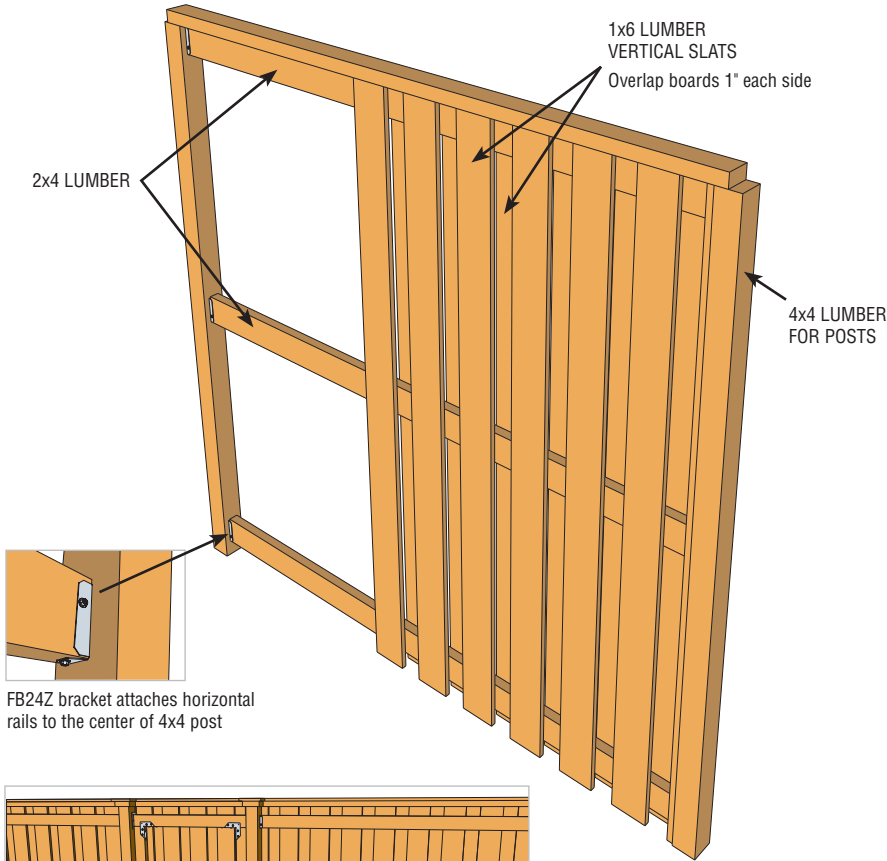

FB24Z bracket attaches horizontal rails to the center of 4x4 post

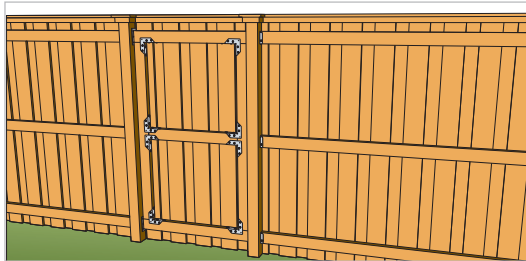

You can create a fence of any style that enhances your home or backyard. Whether you prefer a standard picket fence, three rail, or a lattice top, Simpson Strong-Tie connectors make it easy.

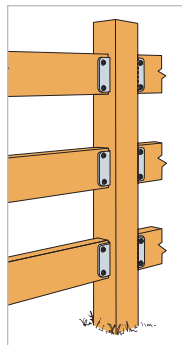
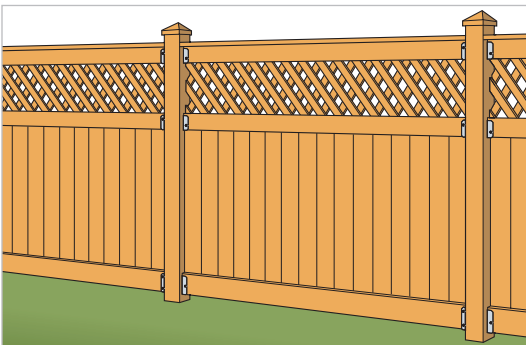

Use cedar, redwood or preservative-treated lumber and finish with exterior grade stain or paint. Make sure posts are designated for below-ground use. Dimensions can be modified to fit your specific needs. Check local building codes before construction.

### TOOLS YOU NEED

- Saw
- Screw gun
- #2 Phillips head bit
- 1/4" hex drive socket
- Tape measure
- Clamps
- Framing square
- Straight edge
- Level
- Post hole digger
- String for layout

### CONNECTING 2x4 HORIZONTAL RAILS (FB24Z BRACKET)

Mark the desired position and use a FB24Z fence bracket to hold the horizontal rails to the center of the 4x4. Attach with Simpson Strong-Tie® #9x1 1/2" Strong-Drive® SD Connector screws.

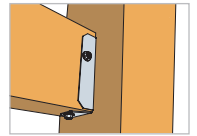

### CONNECTING 2x6 HORIZONTAL RAILS (FB26Z BRACKET)

If you prefer 2x6 rails (or are building a post-and-rail fence) use a FB26Z bracket centered on the post. Attach with #9x1 1/2" SD Connector screws.

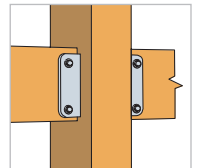

## Wood Fencing

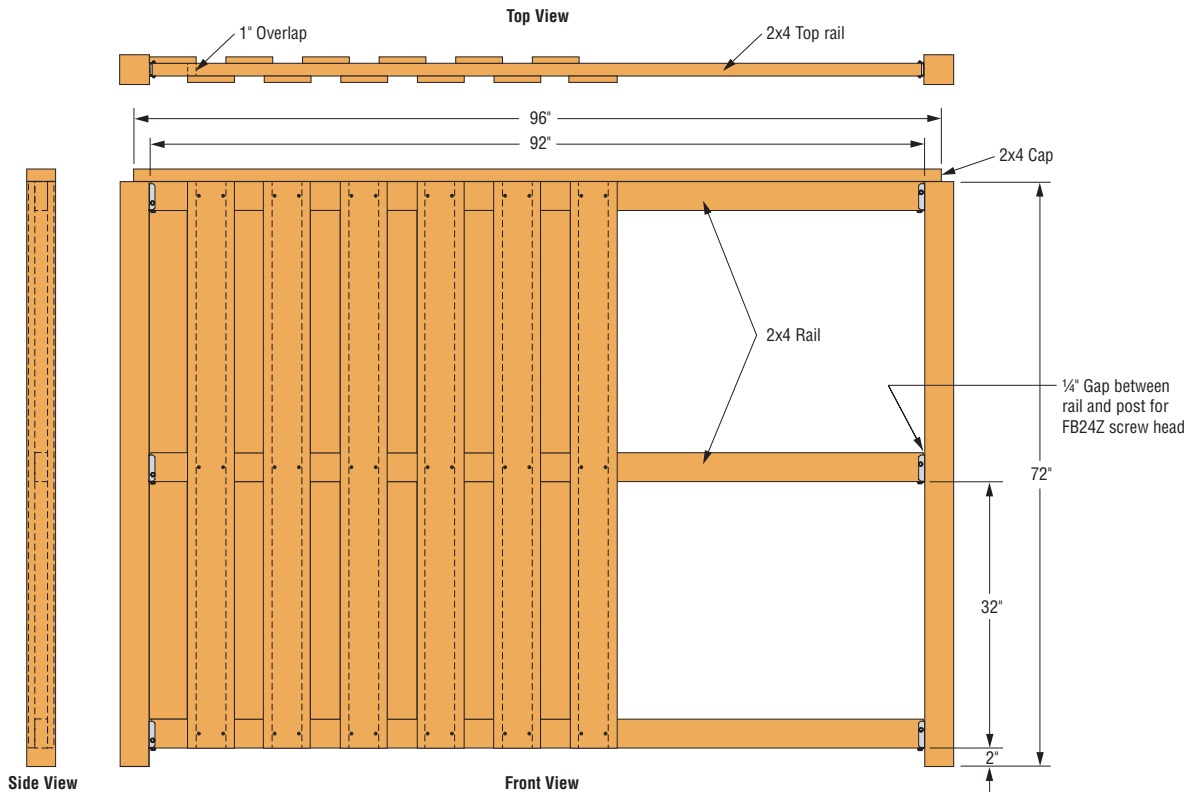

### FOR EACH 8' SECTION YOU WILL NEED:

#### LUMBER

- (2) – pieces 4x4 x 8' lumber\*
- (4) – pieces 2x4 x 8' lumber
- (20) – pieces 1x6 x 6' lumber
- (2) – pieces 1x4 x 6' lumber (for post bracing)
- (2) – wood stakes (for post bracing)

#### SIMPSON STRONG-TIE® CONNECTORS

- (6) – FB24Z fence brackets

#### FASTENERS

- (1) – Box Simpson Strong-Tie #9x1 1/2" Strong-Drive® SD connector screws
- (120) – 1 3/4" decking screws or 8d hot-dip galvanized nails

\*Fence post quantity = number of 8' sections + 1

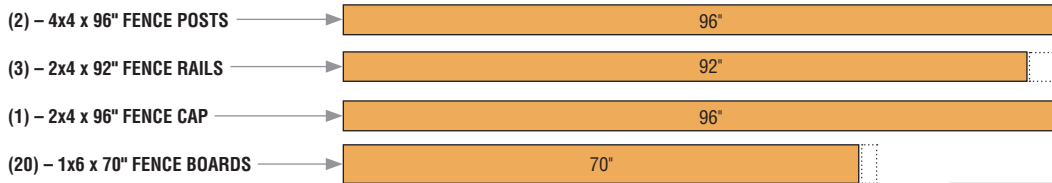

#### SETTING FENCE POSTS

- A common rule of thumb is that a 6' tall fence requires 2' of post in the ground. It is also recommended that a 2" gap be maintained between the bottom of the fence and the ground to help prevent rot. (Check with local building department for specific requirements.)
- Mark the fence line with stakes and string to identify where sides of posts should align. Mark post locations every 8'
- It is recommended that posts be set in concrete for strength and durability.

#### Suggested steps:

1. Dig post holes to desired depth.
2. Position fence post in hole and brace to ensure it is plumb.
3. Pour concrete in hole\*, finishing to a dome at the top to direct water away from the post.

\*There is fence-post concrete readily available in bags that does not require mixing. Typically you can just pour a bag of the dry mix into the hole and add water. (Follow manufacturer's instructions.)

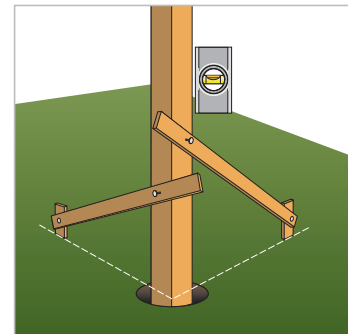

**CORROSION INFORMATION:** We recommend using our ZMAX® galvanized product for best results on exterior projects and those using preservative-treated wood. These products have a "Z" at the end of the model number (ex. FB24Z). ZMAX coated products provide additional corrosion resistance, which is advisable but not required, for non-structural projects like the one shown above. Visit [strongtie.com/info](http://strongtie.com/info) for critical information.

The construction plan for this project is designed to be completed by people with basic carpentry skills in standard situations. If your situation is unique, talk with someone with detailed carpentry or construction experience before starting your project. Particular attention was paid to the steps and details in this plan, but they cannot be guaranteed to be error free. Simpson Strong-Tie shall not be responsible for any possible loss, damage or injury resulting directly or indirectly from the information contained here.